

# SERVICE MANUAL

---

## 27" MTS STEREO COLOR TELEVISION WITH DIGITAL TUNER DTV2798A

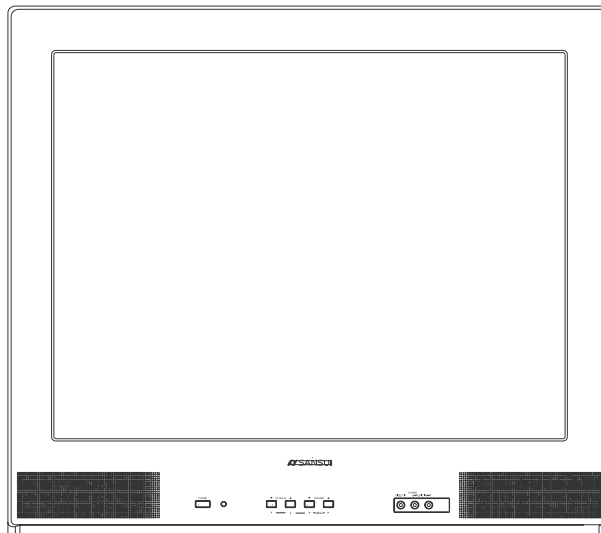

This SUPPLEMENT must be used together with SERVICE MANUAL for DTV2798.  
All other test and repair procedures are as shown in the ORIGINAL MANUAL.  
Please file this SUPPLEMENT with the ORIGINAL VERSIONS.

All the specifications and features are subject to change without notice.

SUPPLEMENT  
VERSION (C)

S/M CODE NO. M33A14SASM  
DATE OF ISSUE 07/2008

### MECHANICAL REPLACEMENT PARTS LIST

REF. NO.	DTV2798		DTV2798A	
	PART NO.	DESCRIPTION	PART NO.	DESCRIPTION
101	7A701B180A	FRONT CABI ASS'Y	7A701B195A	FRONT CABI ASS'Y
101A	701WPD719	CABINET FRONT	701WPD738	CABINET FRONT
101C	713WPA0239	GUIDE REMOCON	713WPA0218	GUIDE REMOCON
101D	735WPA0484	BUTTON,ASS'Y	735WPA0692	BUTTON,ASS'Y
101E	800WQ00103	FELT SHEET 9*250*T0.3		DELETE
101F	800WQ0A068	FELT SHEET	800WQ0A041	FELT SHEET
104	800WR0A002	SHEET CRT SUPPORT	800WR0A003	SHEET CRT SUPPORT
106	722465A473	SHEET RATING	722465A497	SHEET RATING
111	769WSAA009	WASHER CRT T=1		DELETE
201	8141H60D5U	SCREW,TAP TITE(P) GW20 6*45 CH HEXAGON	8141H60D0U	SCREW,TAP TITE(P) GW20 6*40 CH HEXAGON
202	811063080U	SCREW TAP TITE(P) BRAZIER 3*8 CH	8110630A2U	SCREW TAP TITE(P) BRAZIER 3*12 CH
---	793WCDD810	GIFT BOX	793WCDD879	GIFT BOX
---	792WHAA097	PACKAGE, TOP (FRONT)	792WHAA138	PACKAGE TOP (FRONT)
---	792WHAA098	PACKAGE, TOP (BACK)	792WHA0431	PACKAGE TOP(BACK)
---	792WHAA099	PACKAGE,BOTTOM	792WHAA137	PACKAGE BOTTOM

### ELECTRICAL REPLACEMENT PARTS LIST

REF. NO.	DTV2798		DTV2798A	
	PART NO.	DESCRIPTION	PART NO.	DESCRIPTION
IC2403	S33A01SF01	MEMORY DATA K8D3216UTC-PI07	S33A08SF02	MEMORY DATA K8P3215UQB-P14B

## WHEN REPLACING EEPROM (MEMORY) IC

### CONFIRMATION OF CHECK SUM, POWER ON TOTAL HOURS, MICON VERSION AND DIGITAL TV MICON FIRMWARE VERSION

Initial total of MEMORY IC, POWER ON total hours, MICON VERSION and Digital TV MICON Firmware VERSION can be checked on the screen. Total hours are displayed in 16 system of notation.

**NOTE: If you set a factory initialization, the total hours is reset to "0".**

**Please refer to "CONFIRMATION OF INITIAL DATA" when SUM DATA is not corresponding.**

1. Turn on the POWER, and set to the TV mode.
2. Set the VOLUME to minimum.
3. Press both VOL. DOWN button on the set and Channel button **(8)** on the remote control for more than 2 seconds.
4. After the confirmation of each check sum, power on total hours, digital tv micon firware and micon version, turn off the power.

NOTE: The each item value might be different according to each set.

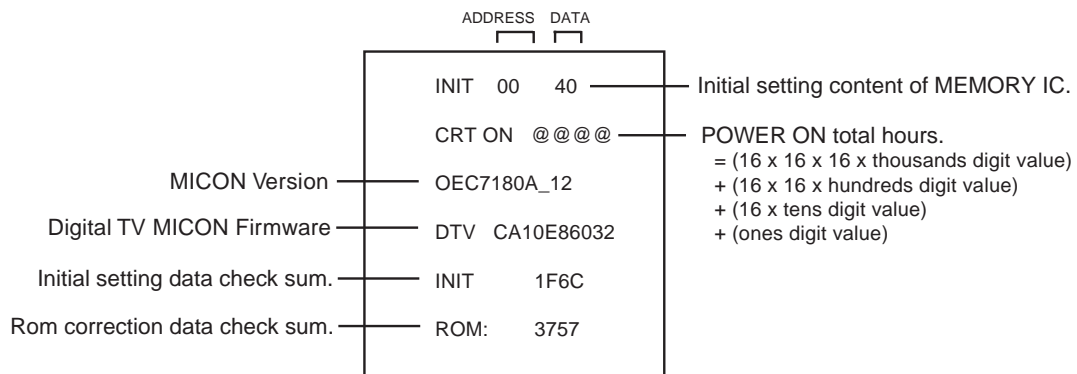
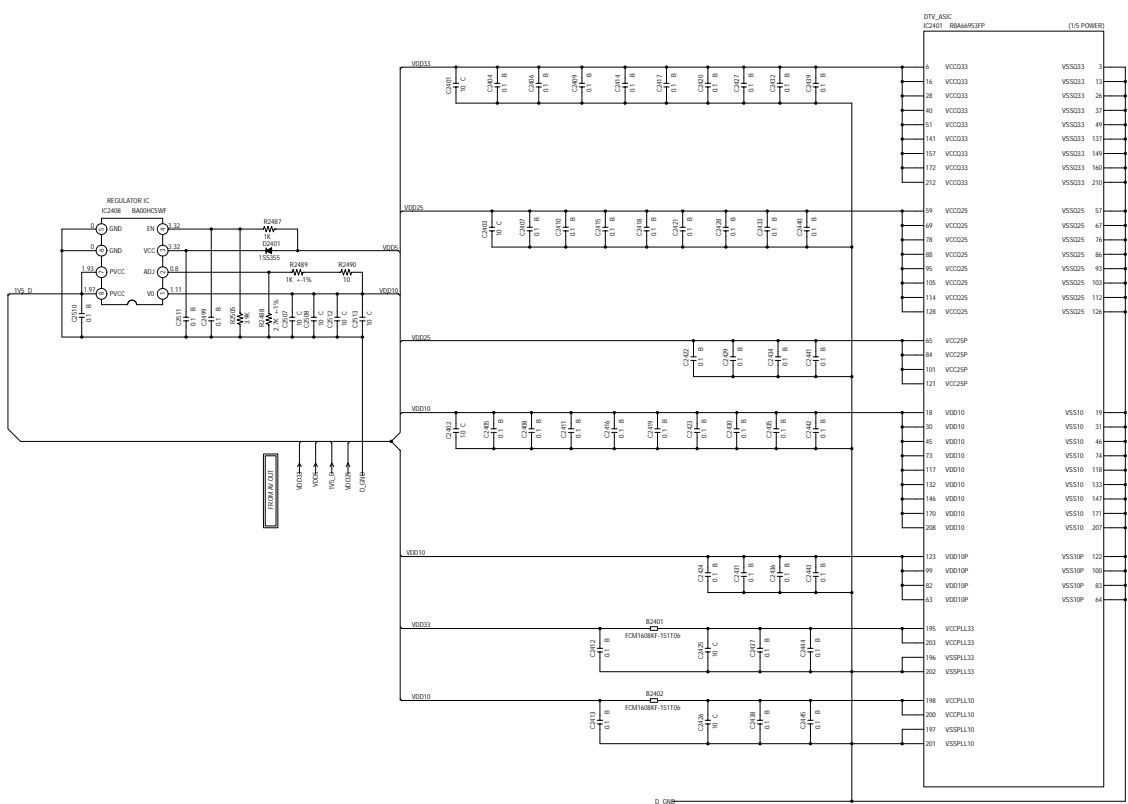

FIG. 1

## POWER2 SCHEMATIC DIAGRAM (DIGITAL PCB)



NOTE: THIS SCHEMATIC DIAGRAM IS THE LATEST AT THE TIME OF PRINTING AND SUBJECT TO CHANGE WITHOUT NOTICE.

NOTE: THE DC VOLTAGE AT EACH PART WAS MEASURED WITH THE DIGITAL TESTER WHEN THE COLOR BROADCAST WAS RECEIVED IN GOOD CONDITION AND PICTURE IS NORMAL.

PCB04  
C17284

# SDRAM SCHEMATIC DIAGRAM (DIGITAL PCB)

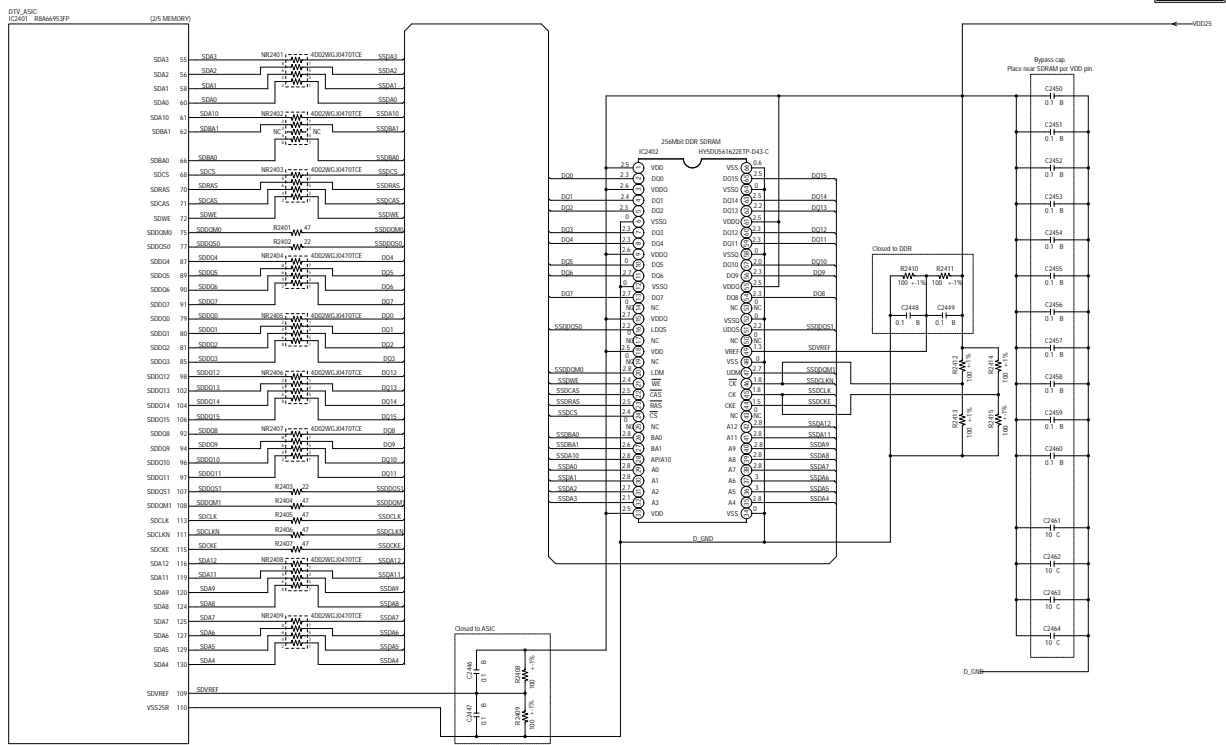

NOTE: THIS SCHEMATIC DIAGRAM IS THE LATEST AT THE TIME OF PRINTING AND SUBJECT TO CHANGE WITHOUT NOTICE.

NOTE: THE DC VOLTAGE AT EACH PART WAS MEASURED WITH THE DIGITAL TESTER WHEN THE COLOR BROADCAST WAS RECEIVED IN GOOD CONDITION AND PICTURE IS NORMAL.

PCB06  
C87284

# FLASH SCHEMATIC DIAGRAM (DIGITAL PCB)

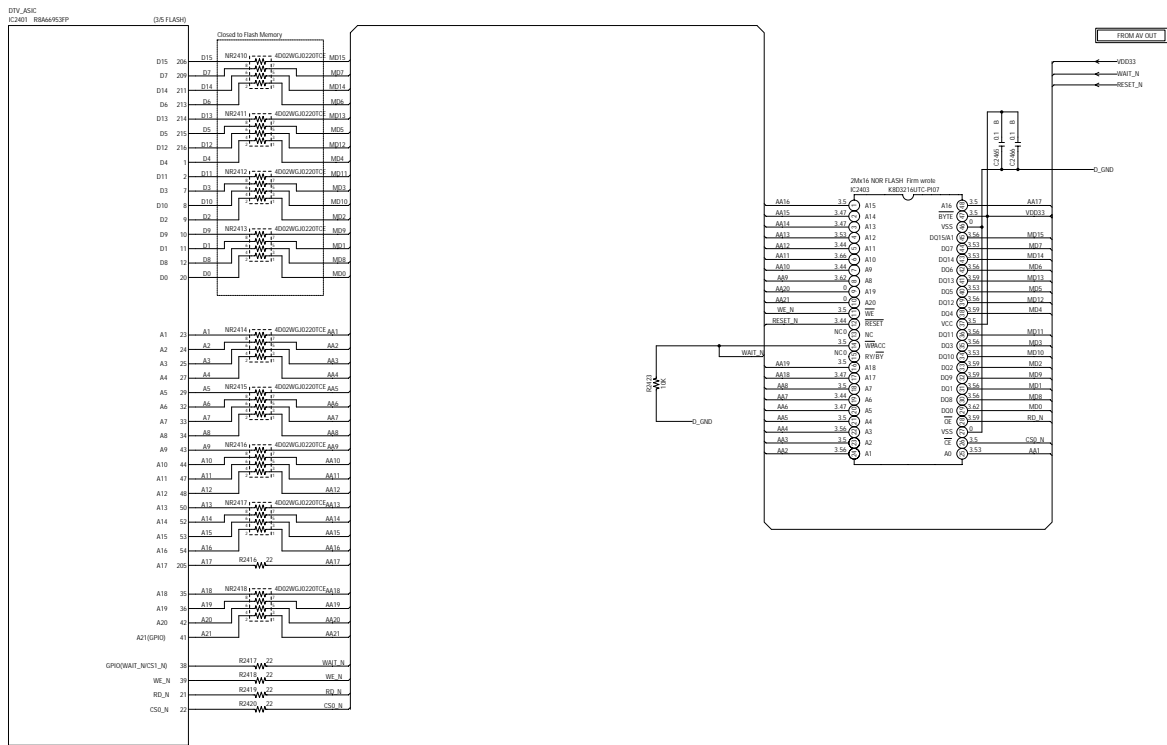

NOTE: THIS SCHEMATIC DIAGRAM IS THE LATEST AT THE TIME OF PRINTING AND SUBJECT TO CHANGE WITHOUT NOTICE.

NOTE: THE DC VOLTAGE AT EACH PART WAS MEASURED WITH THE DIGITAL TESTER WHEN THE COLOR BROADCAST WAS RECEIVED IN GOOD CONDITION AND PICTURE IS NORMAL.

PCB046  
CST284

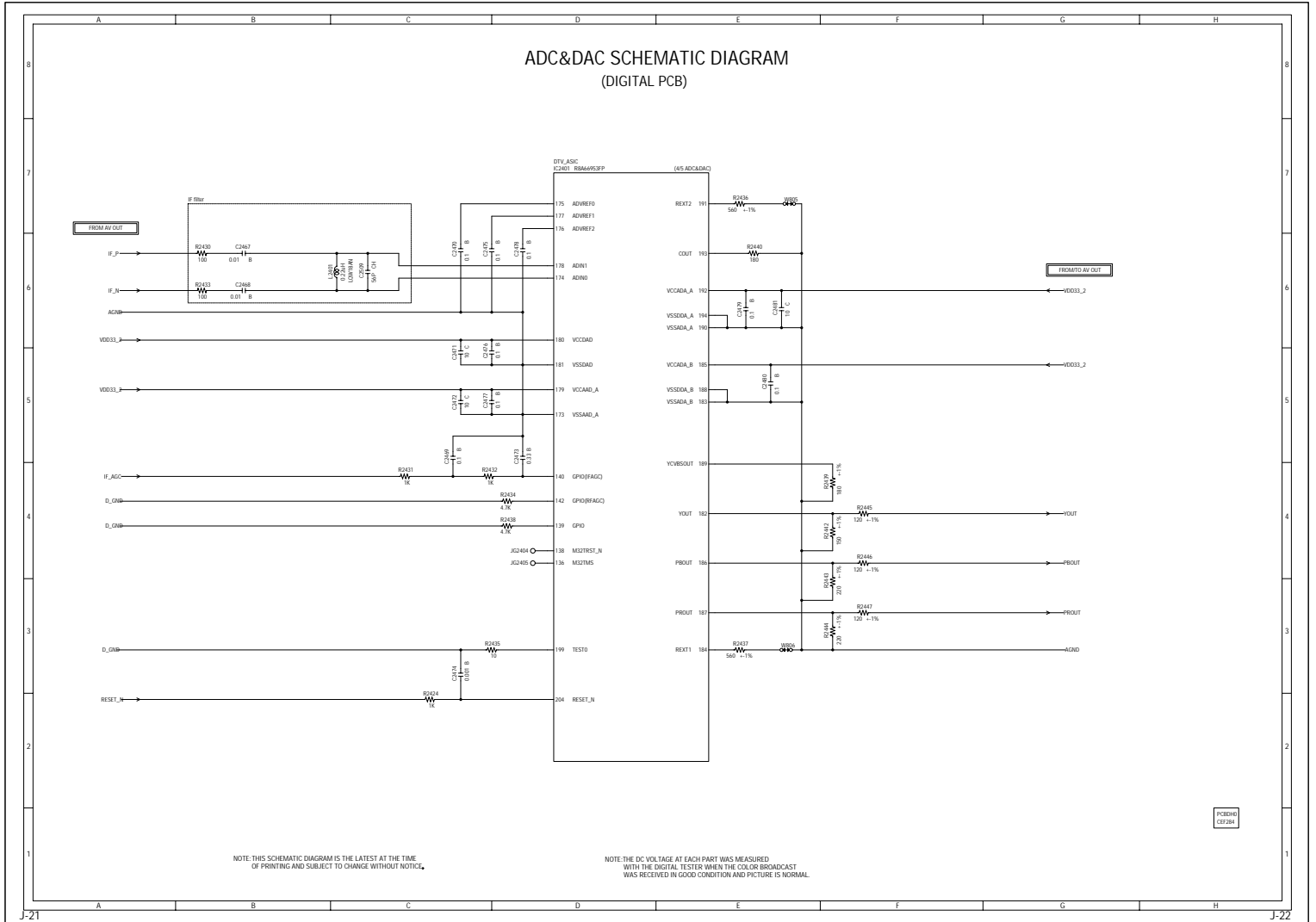





# WAVEFORMS

## DEFLECTION

POWER ON  
5ms  
10.0V

18

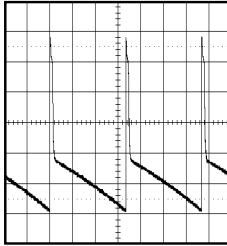

20µs  
2V

23

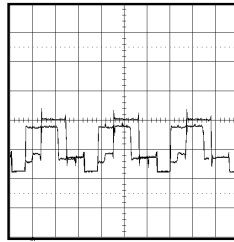

10µs  
200mV

28

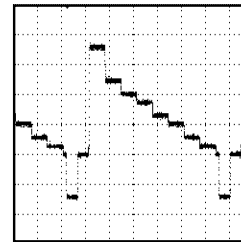

20µs  
20V

19

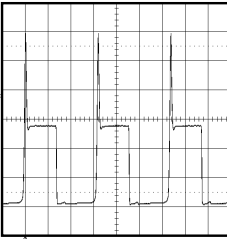

20µs  
2V

24

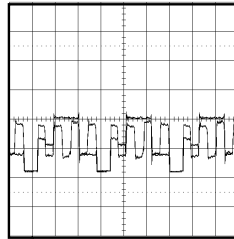

## AV SWITCH/SOUND AMP

20µs  
200mV

29

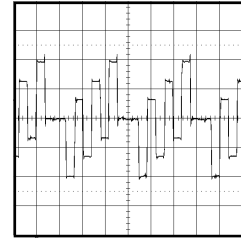

## CHROMA

10µs  
200mV

20

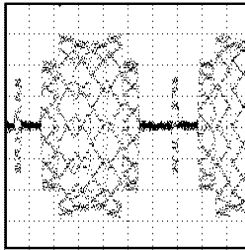

10ms  
0.5V

25

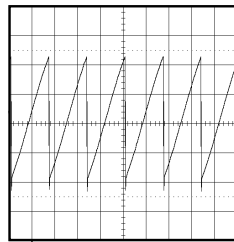

## DEFLECTION

20µs  
2V

30

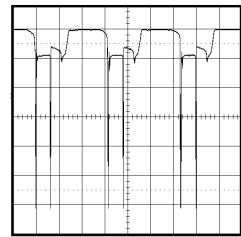

2µs  
1V

21

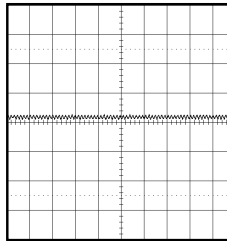

50µs  
1V

26

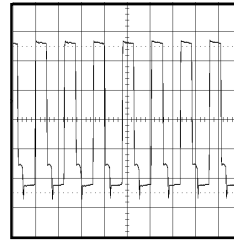

## MICON

50µs  
1V

33

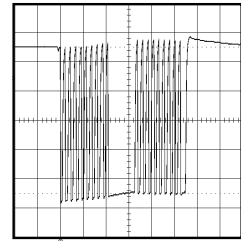

20µs  
1V

22

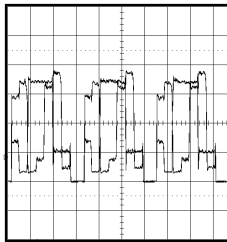

20µs  
2V

27

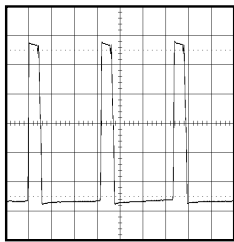

0.1ms  
1V

34

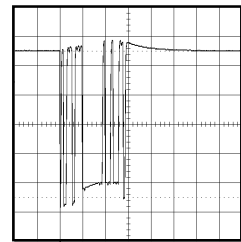

**NOTE:** The following waveforms were measured at the point of the corresponding balloon number in the schematic diagram.

# WAVEFORMS

## DEFLECTION

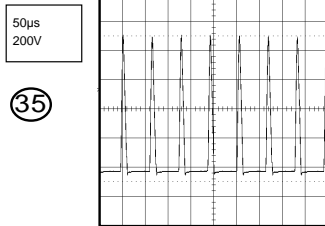

## AV SWITCH/SOUND AMP

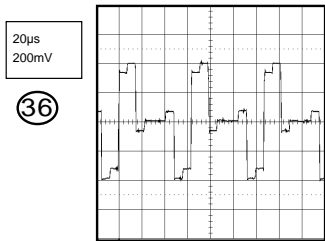

## CRT

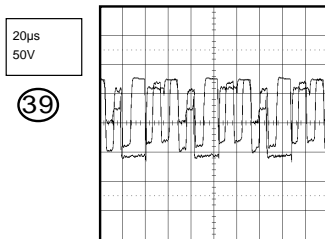
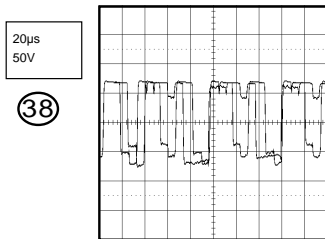
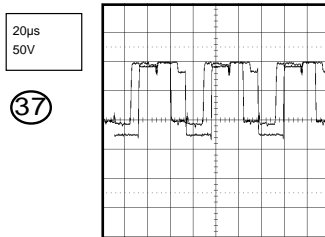

**NOTE:** The following waveforms were measured at the point of the corresponding balloon number in the schematic diagram.

# MECHANICAL EXPLODED VIEW

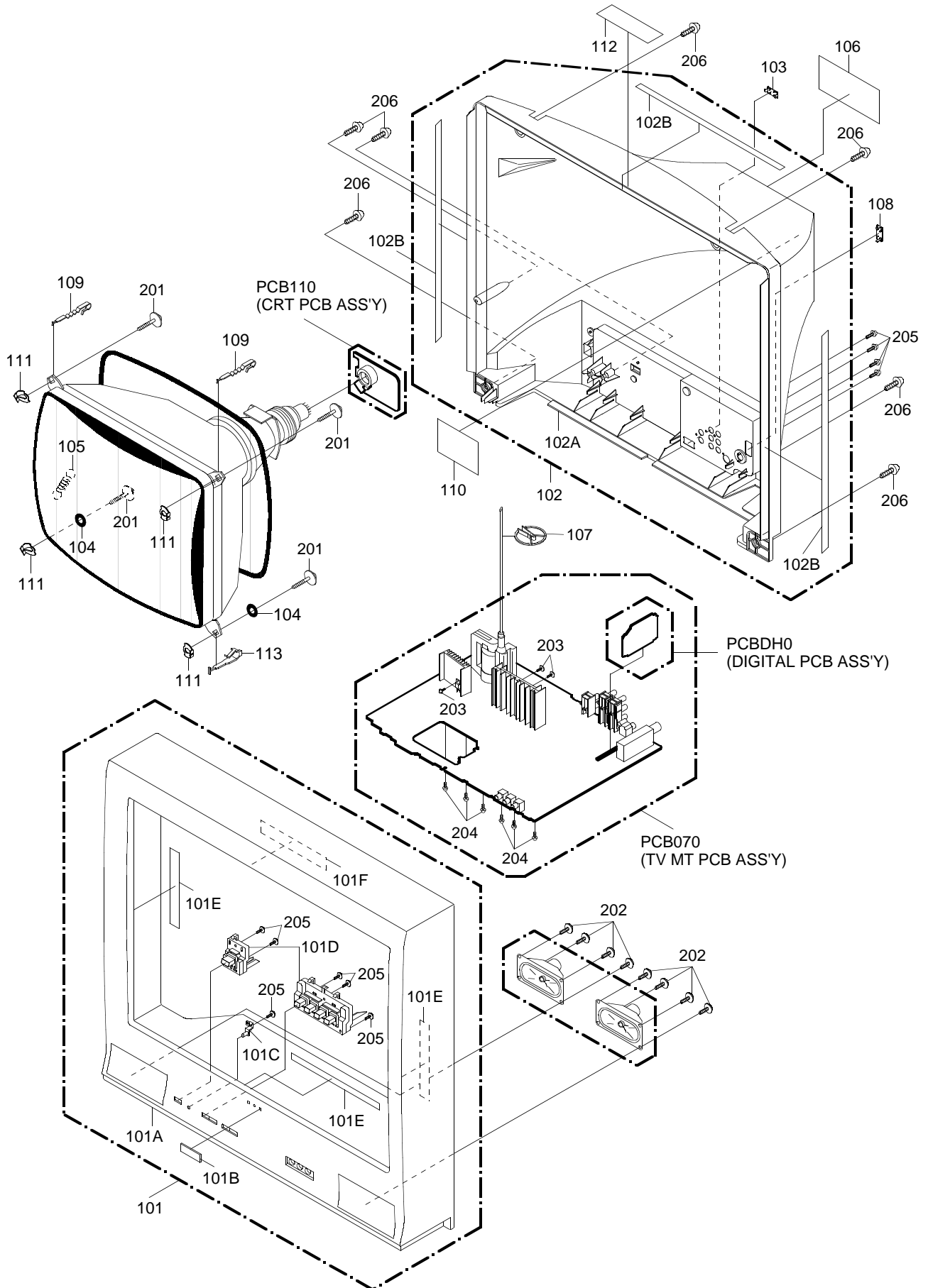

## MECHANICAL REPLACEMENT PARTS LIST

REF. NO.	PART NO.	DESCRIPTION
101	7A701A916A	FRONT CABI ASS'Y
101A	701WPD464	CABINET FRONT
101B	723465A005	BADGE BRAND
101C	713WPAA170	GUIDE,REMOCON
101D	735WPBB491	BUTTON ASS'Y
101E	800WQ00103	FELT SHEET
101F	800WQ0A068	FELT SHEET
		9x250xT0.3
102	7A702A336A	BACK CABI ASS'Y
	7A702A495A	BACK CABI ASS'Y
102A	702WPAB064	CABINET BACK
102B	800WQ0A092	FELT SHEET
		or
103	706WPA0015	COVER CONNECTOR
104	800WR0A002	SHEET CRT SUPPORT
105	741WUA0021	SPRING EARTH
106	722465A466	SHEET RATING
107	899HV3T000	HOLDER ANODE WIRE
108	706WPAA012	COVER CONNECTOR
109	762WPA0009	HOLDER,CRT WIRE
110	726000A151	SHEET CRT SERVICEMAN
111	769WSAA009	WASHER CRT T=1
112	7230007075	SHEET INFORMATION
113	762WPAA006	HOLDER CRT WIRE 2
201	8141H60D5U	SCREW,TAP TITE(P) GW20
		6x45 HEXAGON
202	811063080U	SCREW TAP TITE(P) BRAZIER
		3x8
203	8109130A0U	SCREW TAP TITE(B) WH7
		3x10
204	810963080Q	SCREW TAP TITE(B) BRAZIER
		3x8 STAINLESS
205	8110630A0U	SCREW TAP TITE(P) BRAZIER
		3x10
206	8117540B0U	SCREW TAPPING(B0) TRUSS
		4x20
---	791WHAA115	FILM BAG
---	791WHAA214	LIGHTRON SHEET
---	792WHAA097	PACKAGE, TOP (FRONT)
---	792WHAA098	PACKAGE, TOP (BACK)
---	792WHAA099	PACKAGE, BOTTOM
---	793WCDD670	GIFT BOX

## ACCESSORY REPLACEMENT PARTS LIST

REF. NO.	PART NO.	DESCRIPTION
TM101	076E0NJ010	TRANSMITTER
		CRB07B00
---	J33A0201A	INSATRUCTION BOOK
---	J3T11629A	INFORMATION SHEET(RETURN)
---	JB5ND000	POLYBAG,INSTRUCTION(REDCAUTION)

# ELECTRICAL REPLACEMENT PARTS LIST

REF. NO.	PART NO.	DESCRIPTION	REF. NO.	PART NO.	DESCRIPTION
<b>RESISTORS</b>			<b>RESISTORS</b>		
R001	R803R9101J	RC 100 OHM 1/16W	R405	R803R9223J	RC 22K OHM 1/16W
△ R002	R803R9101J	RC 100 OHM 1/16W	R406	R002T2331J	RC 330 OHM 1/2W
R003	R803R9151J	RC 150 OHM 1/16W	R407	R4X5T6562F	R,METAL 5.6K OHM 1/6W
R005	R803R9223J	RC 22K OHM 1/16W	△ R408	R65582010J	R,FUSE 1 OHM 1/2W
R006	R002T4181J	RC 180 OHM 1/4W	△ R410	R3X18A680J	R,METAL OXIDE 68 OHM 2W
R007	R803R9102J	RC 1K OHM 1/16W	△ R411	R655811R2J	R,FUSE 1.2 OHM 1W
R008	R803R9561F	RC 560 OHM 1/16W	R412	R803R9122J	RC 1.2K OHM 1/16W
R009	R803R9821F	RC 820 OHM 1/16W	R413	R4X5T6183F	R,METAL 18K OHM 1/6W
R010	R803R9391F	RC 390 OHM 1/16W	R414	R4X5T6273F	R,METAL 27K OHM 1/6W
R011	R803R9473J	RC 47K OHM 1/16W	R415	R803R9821J	RC 820 OHM 1/16W
R012	R803R9472J	RC 4.7K OHM 1/16W	△ R416	R002T23R3J	RC 3.3 OHM 1/2W
R013	R803R9472J	RC 4.7K OHM 1/16W	R417	R803R9273J	RC 27K OHM 1/16W
R014	R002T4222J	RC 2.2K OHM 1/4W	R418	R002T2821J	RC 820 OHM 1/2W
R015	R803R9101J	RC 100 OHM 1/16W	△ R420	R002T23R3J	RC 3.3 OHM 1/2W
△ R016	R3X28B5R6J	R,METAL OXIDE 5.6 OHM 3W	△ R421	R3X18A181J	R,METAL OXIDE 180 OHM 2W
R017	R803R9101J	RC 100 OHM 1/16W	R422	R002T2681J	RC 680 OHM 1/2W
R018	R803R9101J	RC 100 OHM 1/16W	R425	R803R9472J	RC 4.7K OHM 1/16W
R019	R803R9103J	RC 10K OHM 1/16W	△ R426	R4X5T6472F	R,METAL 4.7K OHM 1/6W
R020	R803R9472J	RC 4.7K OHM 1/16W	R427	R002T2681J	RC 680 OHM 1/2W
R022	R803R9332J	RC 3.3K OHM 1/16W	R428	R002T4101J	RC 100 OHM 1/4W
R023	R803R9332J	RC 3.3K OHM 1/16W	R430	R002T2124J	RC 120K OHM 1/2W
R024	R803R9471J	RC 470 OHM 1/16W	R431	R803R9472J	RC 4.7K OHM 1/16W
R025	R803R9681J	RC 680 OHM 1/16W	R432	R002T2822J	RC 8.2K OHM 1/2W
R028	R002T4332J	RC 3.3K OHM 1/4W	△ R434	R5X2CF8R2J	R,CEMENT 8.2 OHM 10W
R101	R803R9103J	RC 10K OHM 1/16W	R437	R002T2010J	RC 1 OHM 1/2W
R102	R803R9222J	RC 2.2K OHM 1/16W	△ R438	R655811R2J	R,FUSE 1.2 OHM 1W
R103	R002T4101J	RC 100 OHM 1/4W	△ R439	R3K581102J	R,METAL OXIDE 1K OHM 1W
R104	R803R9222J	RC 2.2K OHM 1/16W	△ R441	R4X5T6333F	R,METAL 33K OHM 1/6W
R106	R803R9332J	RC 3.3K OHM 1/16W	R442	R803R9102J	RC 1K OHM 1/16W
R107	R803R9101J	RC 100 OHM 1/16W	R443	R002T2223J	RC 22K OHM 1/2W
R108	R002T4103J	RC 10K OHM 1/4W	R444	R803R9334J	RC 330K OHM 1/16W
R109	R803R9103J	RC 10K OHM 1/16W	△ R452	R3X18A101J	R,METAL OXIDE 100 OHM 2W
R111	R803R9101J	RC 100 OHM 1/16W	△ R459	R65582R2J	R,FUSE 2.2 OHM 1/2W
R113	R803R9101J	RC 100 OHM 1/16W	△ R500	R0G3K2275K	RC 2.7M OHM 1/2W
R114	R803R9101J	RC 100 OHM 1/16W	△ R501	R5X2AE010J	R,CEMENT 1 OHM 7W
R115	R803R9100J	RC 10 OHM 1/16W	△ R502	R3K78A331J	R,METAL OXIDE 330 OHM 2W
R116	R803R9105J	RC 1M OHM 1/16W	R504	R002T4331J	RC 330 OHM 1/4W
R117	R803R9102J	RC 1K OHM 1/16W	R505	R002T4103J	RC 10K OHM 1/4W
R118	R002T4101J	RC 100 OHM 1/4W	△ R506	R002T4682J	RC 6.8K OHM 1/4W
R119	R002T4472J	RC 4.7K OHM 1/4W	R507	R002T2823J	RC 82K OHM 1/2W
R120	R002T4470J	RC 47 OHM 1/4W	R508	R002T4101J	RC 100 OHM 1/4W
R121	R803R9100J	RC 10 OHM 1/16W	R510	R002T4101J	RC 100 OHM 1/4W
R122	R002T4101J	RC 100 OHM 1/4W	R511	R803R9223J	RC 22K OHM 1/16W
R123	R002T4472J	RC 4.7K OHM 1/4W	R512	R002T4102J	RC 1K OHM 1/4W
R124	R002T4472J	RC 4.7K OHM 1/4W	R513	R002T4103J	RC 10K OHM 1/4W
R125	R803R9561J	RC 560 OHM 1/16W	R515	R002T4472J	RC 4.7K OHM 1/4W
R126	R803R9100J	RC 10 OHM 1/16W	R516	R803R9103J	RC 10K OHM 1/16W
R127	R803R9272J	RC 2.7K OHM 1/16W	R518	R803R9103J	RC 10K OHM 1/16W
R128	R803R9472J	RC 4.7K OHM 1/16W	R519	R002T4103J	RC 10K OHM 1/4W
R129	R803R9102J	RC 1K OHM 1/16W	△ R520	R002T2155J	RC 1.5M OHM 1/2W
R130	R002T4333J	RC 33K OHM 1/4W	R521	R002T4100J	RC 10 OHM 1/4W
R131	R803R9272J	RC 2.7K OHM 1/16W	△ R522	R65582150J	R,FUSE 15 OHM 1/2W
R132	R002T4472J	RC 4.7K OHM 1/4W	R524	R002T4102J	RC 1K OHM 1/4W
R133	R803R9561J	RC 560 OHM 1/16W	R525	R002T2683J	RC 68K OHM 1/2W
R134	R803R9472J	RC 4.7K OHM 1/16W	R526	R002T2683J	RC 68K OHM 1/2W
R135	R803R9103J	RC 10K OHM 1/16W	R528	R002T4101J	RC 100 OHM 1/4W
R136	R803R9102J	RC 1K OHM 1/16W	R529	R002T4102J	RC 1K OHM 1/4W
R138	R803R9101J	RC 100 OHM 1/16W	R530	R002T4222J	RC 2.2K OHM 1/4W
R159	R803R9103J	RC 10K OHM 1/16W	R532	R803R9152J	RC 1.5K OHM 1/16W
R162	R803R9103J	RC 10K OHM 1/16W	R533	R803R9271J	RC 270 OHM 1/16W
R175	R803R9152J	RC 1.5K OHM 1/16W	R539	R002T2125J	RC 1.2M OHM 1/2W
R176	R803R9102J	RC 1K OHM 1/16W	R540	R002T2125J	RC 1.2M OHM 1/2W
R178	R803R9392J	RC 3.9K OHM 1/16W	△ R541	R63881R22J	R,FUSE 0.22 OHM 1W
R189	R803R9472J	RC 4.7K OHM 1/16W	△ R542	R3X181R22J	R,METAL OXIDE 0.22 OHM 1W
R201	R803R9221J	RC 220 OHM 1/16W	R543	R002T2102J	RC 1K OHM 1/2W
R202	R803R9392J	RC 3.9K OHM 1/16W	R544	R002T4271J	RC 270 OHM 1/4W
R205	R803R9181J	RC 180 OHM 1/16W	R545	R002T4151J	RC 150 OHM 1/4W
R211	R803R9241J	RC 240 OHM 1/16W	R546	R002T4101J	RC 100 OHM 1/4W
R212	R803R9241J	RC 240 OHM 1/16W	R547	R002T4102J	RC 1K OHM 1/4W
R213	R803R9471J	RC 470 OHM 1/16W	R548	R803R9101J	RC 100 OHM 1/16W
R216	R803R9512J	RC 5.1K OHM 1/16W	R549	R002T4473J	RC 47K OHM 1/4W
R217	R803R9104J	RC 100K OHM 1/16W	R552	R002T4103J	RC 10K OHM 1/4W
R218	R803R9104J	RC 100K OHM 1/16W	R553	R002T2473J	RC 47K OHM 1/2W
R219	R803R9102J	RC 1K OHM 1/16W	R554	R002T2823J	RC 82K OHM 1/2W
R220	R803R9152J	RC 1.5K OHM 1/16W	R601	R002T4101J	RC 100 OHM 1/4W
R401	R002T2122J	RC 1.2K OHM 1/2W	R602	R803R9102J	RC 1K OHM 1/16W
R404	R803R9682J	RC 6.8K OHM 1/16W	△ R603	R3X18A560J	R,METAL OXIDE 56 OHM 2W

# ELECTRICAL REPLACEMENT PARTS LIST

REF. NO.	PART NO.	DESCRIPTION	REF. NO.	PART NO.	DESCRIPTION
<b>RESISTORS</b>			<b>RESISTORS</b>		
R604	R002T4101J	RC 100 OHM 1/4W	R901	R803R9822J	RC 8.2K OHM 1/16W
R605	R002T4333J	RC 33K OHM 1/4W	R902	R803R9472J	RC 4.7K OHM 1/16W
R606	R002T4101J	RC 100 OHM 1/4W	R904	R803R9101J	RC 100 OHM 1/16W
R607	R803R9123J	RC 12K OHM 1/16W	R905	R803R9101J	RC 100 OHM 1/16W
R608	R002T4472J	RC 4.7K OHM 1/4W	R907	R803R9101J	RC 100 OHM 1/16W
R609	R803R9101J	RC 100 OHM 1/16W	R912	R803R9473J	RC 47K OHM 1/16W
R610	R803R9101J	RC 100 OHM 1/16W	R913	R803R9102J	RC 1K OHM 1/16W
R611	R803R9101J	RC 100 OHM 1/16W	R914	R803R9222J	RC 2.2K OHM 1/16W
R612	R002T4101J	RC 100 OHM 1/4W	R915	R803R9335J	RC 3.3M OHM 1/16W
R613	R002T2101J	RC 100 OHM 1/2W	R1001	R002T4683J	RC 68K OHM 1/4W
R615	R803R9562J	RC 5.6K OHM 1/16W	R1002	R002T4473J	RC 47K OHM 1/4W
R616	R002T4681J	RC 680 OHM 1/4W	R1003	R803R9274J	RC 270K OHM 1/16W
R617	R803R9153J	RC 15K OHM 1/16W	R1006	R803R9102J	RC 1K OHM 1/16W
R618	R002T4221J	RC 220 OHM 1/4W	R1008	R803R9102J	RC 1K OHM 1/16W
R619	R4X5T6472F	R,METAL 4.7K OHM 1/6W	R1010	R803R9102J	RC 1K OHM 1/16W
R622	R002T4391J	RC 390 OHM 1/4W	R1014	R803R9562J	RC 5.6K OHM 1/16W
R623	R002T4101J	RC 100 OHM 1/4W	R1015	R803R9562J	RC 5.6K OHM 1/16W
R624	R803R9274J	RC 270K OHM 1/16W	R1016	R002T4563J	RC 56K OHM 1/4W
R625	R803R9123J	RC 12K OHM 1/16W	R1017	R803R9333J	RC 33K OHM 1/16W
R626	R803R9123J	RC 12K OHM 1/16W	R2401	R808R9470J	RC 47 OHM 1/16W
R627	R002T4331J	RC 330 OHM 1/4W	R2402	R808R9220J	RC 22 OHM 1/16W
R628	R002T4103J	RC 10K OHM 1/4W	R2403	R808R9220J	RC 22 OHM 1/16W
R629	R002T4101J	RC 100 OHM 1/4W	R2404	R808R9470J	RC 47 OHM 1/16W
R630	R803R9102J	RC 1K OHM 1/16W	R2405	R808R9470J	RC 47 OHM 1/16W
R632	R002T4101J	RC 100 OHM 1/4W	R2406	R808R9470J	RC 47 OHM 1/16W
R635	R803R9472J	RC 4.7K OHM 1/16W	R2407	R808R9470J	RC 47 OHM 1/16W
R636	R002T4562J	RC 5.6K OHM 1/4W	R2408	R808R9101F	RC 100 OHM 1/16W
R638	R803R9472J	RC 4.7K OHM 1/16W	R2409	R808R9101F	RC 100 OHM 1/16W
R640	R002T2330J	RC 33 OHM 1/2W	R2410	R808R9101F	RC 100 OHM 1/16W
R645	R002T4470J	RC 47 OHM 1/4W	R2411	R808R9101F	RC 100 OHM 1/16W
R648	R002T4102J	RC 1K OHM 1/4W	R2412	R808R9101F	RC 100 OHM 1/16W
△R650	R3K78B150J	R,METAL OXIDE 15 OHM 3W	R2413	R808R9101F	RC 100 OHM 1/16W
R652	R803R9750J	RC 75 OHM 1/16W	R2414	R808R9101F	RC 100 OHM 1/16W
R653	R803R9750J	RC 75 OHM 1/16W	R2415	R808R9101F	RC 100 OHM 1/16W
R654	R002T4750J	RC 75 OHM 1/4W	R2416	R808R9220J	RC 22 OHM 1/16W
R656	R803R9123J	RC 12K OHM 1/16W	R2417	R808R9220J	RC 22 OHM 1/16W
R659	R803R9105J	RC 1M OHM 1/16W	R2418	R808R9220J	RC 22 OHM 1/16W
R660	R803R9105J	RC 1M OHM 1/16W	R2419	R808R9220J	RC 22 OHM 1/16W
R703	R803R9102J	RC 1K OHM 1/16W	R2420	R808R9220J	RC 22 OHM 1/16W
R704	R803R9102J	RC 1K OHM 1/16W	R2423	R808R9103J	RC 10K OHM 1/16W
R705	R002T4101J	RC 100 OHM 1/4W	R2424	R808R9102J	RC 1K OHM 1/16W
R710	R803R9821J	RC 820 OHM 1/16W	R2430	R808R9101J	RC 100 OHM 1/16W
R711	R803R9821J	RC 820 OHM 1/16W	R2431	R808R9102J	RC 1K OHM 1/16W
R714	R803R9823J	RC 82K OHM 1/16W	R2432	R808R9102J	RC 1K OHM 1/16W
R717	R803R9823J	RC 82K OHM 1/16W	R2433	R808R9101J	RC 100 OHM 1/16W
R726	R803R9102J	RC 1K OHM 1/16W	R2434	R808R9472J	RC 4.7K OHM 1/16W
R730	R803R9221J	RC 220 OHM 1/16W	R2435	R808R9100J	RC 10 OHM 1/16W
R733	R803R9102J	RC 1K OHM 1/16W	R2436	R808R9561F	RC 560 OHM 1/16W
R735	R803R9750J	RC 75 OHM 1/16W	R2437	R808R9561F	RC 560 OHM 1/16W
R736	R803R9221J	RC 220 OHM 1/16W	R2438	R808R9472J	RC 4.7K OHM 1/16W
R739	R803R9750J	RC 75 OHM 1/16W	R2439	R808R9181F	RC 180 OHM 1/16W
R743	R803R9823J	RC 82K OHM 1/16W	R2440	R808R9181J	RC 180 OHM 1/16W
R744	R803R9823J	RC 82K OHM 1/16W	R2441	R808R9562J	RC 5.6K OHM 1/16W
R745	R002T4102J	RC 1K OHM 1/4W	R2442	R808R9151F	RC 150 OHM 1/16W
R746	R002T4102J	RC 1K OHM 1/4W	R2443	R808R9221F	RC 220 OHM 1/16W
R801	R803R9221J	RC 220 OHM 1/16W	R2444	R808R9221F	RC 220 OHM 1/16W
R802	R002T4272J	RC 2.7K OHM 1/4W	R2445	R808R9121F	RC 120 OHM 1/16W
△R803	R3X18A153J	R,METAL OXIDE 15K OHM 2W	R2446	R808R9121F	RC 120 OHM 1/16W
R804	R002T4272J	RC 2.7K OHM 1/4W	R2447	R808R9121F	RC 120 OHM 1/16W
△R805	R3X18A153J	R,METAL OXIDE 15K OHM 2W	R2449	R808R9562J	RC 5.6K OHM 1/16W
R806	R002T4272J	RC 2.7K OHM 1/4W	R2450	R808R9562J	RC 5.6K OHM 1/16W
△R807	R3X18A153J	R,METAL OXIDE 15K OHM 2W	R2453	R808R9102J	RC 1K OHM 1/16W
R808	R803R9221J	RC 220 OHM 1/16W	R2454	R808R9562J	RC 5.6K OHM 1/16W
R809	R803R9122J	RC 1.2K OHM 1/16W	R2455	R808R9562J	RC 5.6K OHM 1/16W
R810	R803R9221J	RC 220 OHM 1/16W	R2456	R808R9562J	RC 5.6K OHM 1/16W
R811	R803R9122J	RC 1.2K OHM 1/16W	R2457	R808R9562J	RC 5.6K OHM 1/16W
R812	R803R9101J	RC 100 OHM 1/16W	R2458	R808R9562J	RC 5.6K OHM 1/16W
R813	R803R9181J	RC 180 OHM 1/16W	R2460	R808R9102J	RC 1K OHM 1/16W
R814	R803R9122J	RC 1.2K OHM 1/16W	R2462	R808R9105J	RC 1M OHM 1/16W
R815	R803R9181J	RC 180 OHM 1/16W	R2463	R808R9102J	RC 1K OHM 1/16W
R816	R803R9181J	RC 180 OHM 1/16W	R2465	R808R9220J	RC 22 OHM 1/16W
R817	R803R9680J	RC 68 OHM 1/16W	R2466	R808R9102J	RC 1K OHM 1/16W
R818	R803R9680J	RC 68 OHM 1/16W	R2467	R808R9104J	RC 100K OHM 1/16W
R819	R803R9680J	RC 68 OHM 1/16W	R2468	R808R9223J	RC 22K OHM 1/16W
R820	R803R9101J	RC 100 OHM 1/16W	R2469	R808R9104J	RC 100K OHM 1/16W
R821	R803R9101J	RC 100 OHM 1/16W	R2470	R808R9223J	RC 22K OHM 1/16W
R824	R002T2560J	RC 56 OHM 1/2W	R2471	R808R9102J	RC 1K OHM 1/16W

# ELECTRICAL REPLACEMENT PARTS LIST

REF. NO.	PART NO.	DESCRIPTION	REF. NO.	PART NO.	DESCRIPTION
<b>RESISTORS</b>			<b>CAPACITORS</b>		
R2472	R808R9153J	RC 15K OHM 1/16W	C141	CQGTC4L1J	CC 33 PF 50V CH
R2473	R808R9153J	RC 15K OHM 1/16W	C142	CS0PB0N16K	CC 1 UF 10V B
R2474	R808R9103J	RC 10K OHM 1/16W	C143	CS0PCH412J	CC 100 PF 50V CH
R2475	R808R9103J	RC 10K OHM 1/16W	C144	CS0PCH4L1J	CC 33 PF 50V CH
R2478	R808R9471J	RC 470 OHM 1/16W	C146	CS0PB04H3K	CC 0.0022UF 50V B
R2479	R808R9471J	RC 470 OHM 1/16W	C147	CS0PCH4S1J	CC 56 PF 50V CH
R2482	R808R9562J	RC 5.6K OHM 1/16W	C148	CS0PCH4S1J	CC 56 PF 50V CH
R2483	R808R9562J	RC 5.6K OHM 1/16W	C204	CS0PB0414K	CC 0.01 UF 50V B
R2484	R808R9562J	RC 5.6K OHM 1/16W	C205	E70QU0101M	CE 100 UF 6.3V
R2487	R808R9102J	RC 1K OHM 1/16W	C207	CS0PB04Q4K	CC 0.047 UF 50V B
R2488	R808R9272F	RC 2.7K OHM 1/16W	C208	CS0PB0315K	CC 0.1 UF 25V B
R2489	R808R9102F	RC 1K OHM 1/16W	C209	CS0PB0N16K	CC 1 UF 10V B
R2490	R808R9100J	RC 10 OHM 1/16W	C210	CS0PCH4L2J	CC 330 PF 50V CH
R2505	R808R9392J	RC 3.9K OHM 1/16W	C212	CS0PB0413K	CC 0.001 UF 50V B
<b>CAPACITORS</b>					
C001	CS0PB0315K	CC 0.1 UF 25V B	C213	CS0PCH460D	CC 6 PF 50V CH
C002	E7EPU0471M	CE 470 UF 6.3V	C214	CS0PRH4E1J	CC 15 PF 50V RH
C003	CS0PB0315K	CC 0.1 UF 25V B	C215	CS0PCH4M1J	CC 36 PF 50V CH
C004	CS0PB0415K	CC 0.1 UF 50V B	C216	CS0PB0414K	CC 0.01 UF 50V B
C007	CS0PB0315K	CC 0.1 UF 25V B	C217	CS0PCH4K1J	CC 27 PF 50V CH
C008	E7EPU0471M	CE 470 UF 6.3V	C218	CS0PCH4K1J	CC 27 PF 50V CH
C009	CS0PB04Q3K	CC 0.0047UF 50V B	C219	CS0PB04H3K	CC 0.0022UF 50V B
C010	E7EPU1471M	CE 470 UF 10V	C401	C0JTL5K1J	CC 27 PF 500V SL
	E02LU1471M	CE 470 UF 10V	C402	P232W1103J	CMP 0.01 UF 100V MMTS
C011	CS0PB0315K	CC 0.1 UF 25V B	C403	E7EPU5220M	CE 22 UF 50V
C012	E7EPU0221M	CE 220 UF 6.3V	C404	CS0PB04H3K	CC 0.0022UF 50V B
C013	CS0PB0315K	CC 0.1 UF 25V B	C405	E70RU34R7M	CE 4.7 UF 25V
C014	E7EPU0471M	CE 470 UF 6.3V		E00NU34R7M	CE 4.7 UF 25V
C015	CS0PB0315K	CC 0.1 UF 25V B	C406	E7EPU5010M	CE 1 UF 50V
C016	CS0PCH4N1J	CC 39 PF 50V CH	C407	E7EPU4101M	CE 100 UF 35V
C018	CS0PCH4N1J	CC 39 PF 50V CH		E02LU4101M	CE 100 UF 35V
C020	CS0PCH4H2J	CC 220 PF 50V CH	△C408	E7ESF3222M	CE 2200 UF 25V
C021	CS0PCH4Q1J	CC 47 PF 50V CH	C410	CHGTB04H2J	CC 220 PF 50V B
C023	E7EPU0471M	CE 470 UF 6.3V	△C412	P4G8FJ332H	CMP 0.0033UF 1.25KV PHE or
C024	CS0PCH4H2J	CC 220 PF 50V CH		P4N8FJ332H	CMP 0.0033UF 1.25KV
C025	CS0PB04H3K	CC 0.0022UF 50V B	△C413	E7EPF4102M	CE 1000 UF 35V
C026	E7EPU0101M	CE 100 UF 6.3V	C416	CS0PCH412J	CC 100 PF 50V CH
	E7EPU1101M	CE 100 UF 10V	C417	P235W1224J	CMP 0.22 UF 100V MKT
C027	CS0PCH4H2J	CC 220 PF 50V CH	△C418	P4J7F3434J	CMP 0.43 UF 250V PMS
C029	CS0PCH4H2J	CC 220 PF 50V CH	C419	C0JTB05H3K	CC 0.0022UF 500V B
C030	CS0PCH412J	CC 100 PF 50V CH	△C420	P4N8FJ183H	CMP 0.018 UF 1.25KV
C031	CS0PB0414K	CC 0.01 UF 50V B	△C421	P3G1F5223J	CC 0.022 UF 630V PP
C032	CS0PB0315K	CC 0.1 UF 25V B	C422	P235W1224J	CMP 0.22 UF 100V MKT
C033	CS0PB0414K	CC 0.01 UF 50V B	C423	E70QU54R7M	CE 4.7 UF 50V
C101	E70QU0470M	CE 47 UF 6.3V	C424	CS0PCH412J	CC 100 PF 50V CH
C102	E7EPT0102M	CE 1000 UF 6.3V	C425	C03L0R713K	CC 0.001 UF 2KV R
C103	CS0PB0N16K	CC 1 UF 10V B	△C426	E7ESFD220M	CE 22 UF 250V
C104	E7EPU0101M	CE 100 UF 6.3V	C427	P235W1104J	CMP 0.1 UF 100V MKT
	E7EPU1101M	CE 100 UF 10V	△C430	E7EPU8220M	CE 22 UF 100V
C105	E70QU2220M	CE 22 UF 16V	△C432	E8EBFB470M	CE 47 UF 160V
C106	E70QU54R7M	CE 4.7 UF 50V	C433	E70QU54R7M	CE 4.7 UF 50V
C109	CS0PB0N16K	CC 1 UF 10V B	C436	E7EPU1101M	CE 100 UF 10V
C110	CS0PCH4L1J	CC 33 PF 50V CH	C437	CQGTB04L4K	CC 0.033 UF 50V B
C115	E7EPU0101M	CE 100 UF 6.3V	C438	C0JTB0513K	CC 0.001 UF 500V B
	E7EPU1101M	CE 100 UF 10V	C439	CS0PB0413K	CC 0.001 UF 50V B
C116	CS0PCH412J	CC 100 PF 50V CH	C442	E8EBFD100M	CE 10 UF 250V
C118	E70QU3100M	CE 10 UF 25V	△C501	E7ESF2222M	CE 2200 UF 16V
C119	E70QU5010M	CE 1 UF 50V	△C502	C03L0R713K	CC 0.001 UF 2KV R
C120	CQGTFO416Z	CC 1 UF 50V F	△C503	C03L0R713K	CC 0.001 UF 2KV R
C121	CS0PB0413K	CC 0.001 UF 50V B	△C504	E7EPU5220M	CE 22 UF 50V
C122	CS0PCH4N2J	CC 390 PF 50V CH	△C505	P2122B334M	CMP 0.33 UF 275V ECQUL
C123	E70QU5R47M	CE 0.47 UF 50V	△C506	P2122B224M	CMP 0.22 UF 275V ECQUL
C124	CS0PCH4H2J	CC 220 PF 50V CH	△C507	E71WHC471M	CE 47 UF 200V
C126	CS0PCH4E2J	CC 150 PF 50V CH	△C508	CC3LE0MH3M	CC 0.0022UF 250V
C127	CS0PB0315K	CC 0.1 UF 25V B	C509	E7EPU3470M	CE 47 UF 25V
C129	CS0PB0315K	CC 0.1 UF 25V B	C510	CQGTB0414K	CC 0.01 UF 50V B
C130	CS0PCH421J	CC 20 PF 50V CH	C511	CS0PCH4H2J	CC 220 PF 50V CH
C131	CS0PCH4E1J	CC 15 PF 50V CH	C512	P232W1473J	CMP 0.047 UF 100V MMTS
C132	CS0PB0414K	CC 0.01 UF 50V B	△C513	CC3LE0M13M	CC 0.001 UF 250V
C133	CS0PCH4G1J	CC 18 PF 50V CH	△C514	E7EYT2681M	CE 680 UF 16V
C134	CS0PCH4G1J	CC 18 PF 50V CH	C515	E70QU3100M	CE 10 UF 25V
C135	CS0PB0315K	CC 0.1 UF 25V B	C516	CHGTB0413K	CC 0.001 UF 50V B
C136	CS0PB0315K	CC 0.1 UF 25V B	△C517	C03L0R7K3K	CC 0.0027UF 2KV R
C137	CS0PCH421J	CC 20 PF 50V CH	C518	CHGTB04H2J	CC 220 PF 50V B
C138	CS0PCH4H1J	CC 22 PF 50V CH	△C519	CC3LE0M13M	CC 0.001 UF 250V
C139	CS0PB0N16K	CC 1 UF 10V B	△C520	C0JTB0513K	CC 0.001 UF 500V B
C140	CS0PB0315K	CC 0.1 UF 25V B	△C521	E8E2FB221M	CE 220 UF 160V
			C522	E7EPU2101M	CE 100 UF 16V



# ELECTRICAL REPLACEMENT PARTS LIST

REF. NO.	PART NO.	DESCRIPTION	REF. NO.	PART NO.	DESCRIPTION
<b>CAPACITORS</b>			<b>CAPACITORS</b>		
C524	CQGTB04K3K	CC 0 .0027UF 50V B	C908	CS0PB0315K	CC 0.1 UF 25V B
△C527	E7EPF2222M	CE 2200 UF 16V	C909	E70QU3100M	CE 10 UF 25 V
△C534	CRGTB04H3K	CC 0.0022UF 50V B	C910	E70QU54R7M	CE 4.7 UF 50V
C535	C0PLRR7H3K	CC 0.0022 UF 2KV R	C911	CS0PB0N16K	CC 1 UF 10V B
C537	CQGTCH4H2J	CC 220 PF 50V CH	C912	CS0PB0N16K	CC 1 UF 10V B
C541	CQGTB04S4K	CC 0.056 UF 50V B	C914	CS0PB0N16K	CC 1 UF 10V B
C549	CRGTB04Q4K	CC 0.047 UF 50V B	C915	E70QU3100M	CE 10 UF 25 V
C554	CHGTB0413K	CC 0.001 UF 50V B	C916	CS0PF0NH6Z	CC 2.2 UF 10V F
C601	CS0PB0315K	CC 0.1 UF 25V B	C917	CS0PB04H4K	CC 0.022 UF 50V B
C603	E7EPU1101M	CE 100 UF 10V	C918	CS0PB0315K	CC 0.1 UF 25V B
C604	CS0PB0315K	CC 0.1 UF 25V B	C919	CS0PB0315K	CC 0.1 UF 25V B
C606	CS0PB0N16K	CC 1 UF 10V B	C920	E70QU52R2M	CE 2.2 UF 50V
C609	E7EPU1101M	CE 100 UF 10V	C921	E70QU52R2M	CE 2.2 UF 50V
C611	P232W0474J	CMPL 0.47 UF 50V MMTS	C922	CS0PCH412J	CC 100 PF 50V CH
C612	E7EPU1331M	CE 330 UF 10V	C923	CS0PCH412J	CC 100 PF 50V CH
	E02LU1331M	CE 330 UF 10V	C924	CS0PB04K3K	CC 0.0027UF 50V B
C613	CS0PB0414K	CC 0.01 UF 50V B	C925	CS0PB0316K	CC 1 UF 25V B
C614	CS0PB0N15K	CC 0.33 UF 10V B	C927	E70QU3100M	CE 10 UF 25 V
C615	E7EPU2101M	CE 100 UF 16V	C931	CS0PB0315K	CC 0.1 UF 25V B
C617	CS0PB0N15K	CC 0.33 UF 10V B	C932	E7EPU2470M	CE 47 UF 16V
C618	CS0PB04E4K	CC 0.015 UF 50V B	C933	CS0PB0414K	CC 0.01 UF 50V B
C619	CS0PB0NH6K	CC 2.2 UF 10V B	C1001	CS0PB0N16K	CC 1 UF 10V B
C621	CS0PB0315K	CC 0.1 UF 25V B	C1002	CS0PB04K4K	CC 0.027 UF 50V B
C622	CS0PB02L5K	CC 0.33 UF 16V B	C1003	CS0PB0N16K	CC 1 UF 10V B
C624	E7EPU0221M	CE 220 UF 6.3V	C1004	CS0PB04K4K	CC 0.027 UF 50V B
C626	CS0PB0N16K	CC 1 UF 10V B	C1005	E70QU3100M	CE 10 UF 25 V
C627	CS0PB03Q4K	CC 0.047 UF 25V B	C1006	E7EPU4220M	CE 22 UF 35V
C628	CS0PB0N16K	CC 1 UF 10V B		E7EPU5220M	CE 22 UF 50V
C629	CS0PCH480D	CC 8 PF 50V CH	C1007	CS0PCH4N2J	CC 390 PF 50V CH
C630	CS0PCH480D	CC 8 PF 50V CH	C2401	CS7RC0N17M	CC 10 UF 10V C
C632	E70QU3100M	CE 10 UF 25 V	C2402	CS7RC0N17M	CC 10 UF 10V C
C634	CS0PB0N16K	CC 1 UF 10V B	C2403	CS7RC0N17M	CC 10 UF 10V C
C635	E70QU3100M	CE 10 UF 25 V	C2404	CS0UB0N15K	CC 0.1 UF 10V B
C636	CS0PB0N16K	CC 1 UF 10V B	C2405	CS0UB0N15K	CC 0.1 UF 10V B
C637	CS0PCH4L1J	CC 33 PF 50V CH	C2406	CS0UB0N15K	CC 0.1 UF 10V B
C638	E70QU3100M	CE 10 UF 25 V	C2407	CS0UB0N15K	CC 0.1 UF 10V B
C644	CS0PB0315K	CC 0.1 UF 25V B	C2408	CS0UB0N15K	CC 0.1 UF 10V B
C645	CS0PB0315K	CC 0.1 UF 25V B	C2409	CS0UB0N15K	CC 0.1 UF 10V B
C646	CS0PB0315K	CC 0.1 UF 25V B	C2410	CS0UB0N15K	CC 0.1 UF 10V B
C647	CS0PB0N16K	CC 1 UF 10V B	C2411	CS0UB0N15K	CC 0.1 UF 10V B
C648	E70QU3100M	CE 10 UF 25 V	C2412	CS0UB0N15K	CC 0.1 UF 10V B
C649	E70QU3100M	CE 10 UF 25 V	C2413	CS0UB0N15K	CC 0.1 UF 10V B
C650	E70QU3100M	CE 10 UF 25 V	C2414	CS0UB0N15K	CC 0.1 UF 10V B
C651	E70QU3100M	CE 10 UF 25 V	C2415	CS0UB0N15K	CC 0.1 UF 10V B
C652	E70QU3100M	CE 10 UF 25 V	C2416	CS0UB0N15K	CC 0.1 UF 10V B
C653	E7EPU1101M	CE 100 UF 10V	C2417	CS0UB0N15K	CC 0.1 UF 10V B
C655	E70QU3100M	CE 10 UF 25 V	C2418	CS0UB0N15K	CC 0.1 UF 10V B
C656	E70RU2100M	CE 10 UF 16 V	C2419	CS0UB0N15K	CC 0.1 UF 10V B
C658	CS0PB0315K	CC 0.1 UF 25V B	C2420	CS0UB0N15K	CC 0.1 UF 10V B
C659	CS0PB0315K	CC 0.1 UF 25V B	C2421	CS0UB0N15K	CC 0.1 UF 10V B
C660	CS0PB0315K	CC 0.1 UF 25V B	C2422	CS0UB0N15K	CC 0.1 UF 10V B
C661	CS0PB0315K	CC 0.1 UF 25V B	C2423	CS0UB0N15K	CC 0.1 UF 10V B
C704	CS0PB0N16K	CC 1 UF 10V B	C2424	CS0UB0N15K	CC 0.1 UF 10V B
C707	CS0PB0N16K	CC 1 UF 10V B	C2425	CS7RC0N17M	CC 10 UF 10V C
C714	E70QU3100M	CE 10 UF 25 V	C2426	CS7RC0N17M	CC 10 UF 10V C
C715	E70QU3100M	CE 10 UF 25 V	C2427	CS0UB0N15K	CC 0.1 UF 10V B
C717	E7EPU1101M	CE 100 UF 10V	C2428	CS0UB0N15K	CC 0.1 UF 10V B
C719	CS0PB0315K	CC 0.1 UF 25V B	C2429	CS0UB0N15K	CC 0.1 UF 10V B
C720	CS0PB0315K	CC 0.1 UF 25V B	C2430	CS0UB0N15K	CC 0.1 UF 10V B
C722	CQGTFO416Z	CC 1 UF 50V F	C2431	CS0UB0N15K	CC 0.1 UF 10V B
C725	CS0PB0N16K	CC 1 UF 10V B	C2432	CS0UB0N15K	CC 0.1 UF 10V B
C733	E70QU5010M	CE 1 UF 50V	C2433	CS0UB0N15K	CC 0.1 UF 10V B
C734	CS0PB0315K	CC 0.1 UF 25V B	C2434	CS0UB0N15K	CC 0.1 UF 10V B
C802	C0JBB0713K	CC 0.001 UF 2KV B	C2435	CS0UB0N15K	CC 0.1 UF 10V B
C803	CS0PCH4L1J	CC 33 PF 50V CH	C2436	CS0UB0N15K	CC 0.1 UF 10V B
C804	CS0PCH4L1J	CC 33 PF 50V CH	C2437	CS0UB0N15K	CC 0.1 UF 10V B
C805	CS0PCH4L1J	CC 33 PF 50V CH	C2438	CS0UB0N15K	CC 0.1 UF 10V B
C806	CS0PB0413K	CC 0.001 UF 50V B	C2439	CS0UB0N15K	CC 0.1 UF 10V B
C809	CS0PCH4L2J	CC 330 PF 50V CH	C2440	CS0UB0N15K	CC 0.1 UF 10V B
C810	CS0PCH4K2J	CC 270 PF 50V CH	C2441	CS0UB0N15K	CC 0.1 UF 10V B
C811	CS0PCH4K2J	CC 270 PF 50V CH	C2442	CS0UB0N15K	CC 0.1 UF 10V B
C901	E7EPU54R7M	CE 4.7 UF 50V	C2443	CS0UB0N15K	CC 0.1 UF 10V B
C902	E7EPU54R7M	CE 4.7 UF 50V	C2444	CS0UB0N15K	CC 0.1 UF 10V B
C903	CS0PB0N16K	CC 1 UF 10V B	C2445	CS0UB0N15K	CC 0.1 UF 10V B
C904	CS0PB0315K	CC 0.1 UF 25V B	C2446	CS0UB0N15K	CC 0.1 UF 10V B
C906	CS0PB0N16K	CC 1 UF 10V B	C2447	CS0UB0N15K	CC 0.1 UF 10V B
C907	E7EPU4220M	CE 22 UF 35V	C2448	CS0UB0N15K	CC 0.1 UF 10V B



# ELECTRICAL REPLACEMENT PARTS LIST

REF. NO.	PART NO.	DESCRIPTION	REF. NO.	PART NO.	DESCRIPTION
<b>CAPACITORS</b>			<b>CAPACITORS</b>		
C2449	CS0UB0N15K	CC 0.1 UF 10V B	C2547	CT7RC0P17M	CC 10 UF 6.3V C
C2450	CS0UB0N15K	CC 0.1 UF 10V B	C2548	E62YM2101D	CE 100 UF 16V
C2451	CS0UB0N15K	CC 0.1 UF 10V B	C2549	CS0UB0N15K	CC 0.1 UF 10V B
C2452	CS0UB0N15K	CC 0.1 UF 10V B	C2550	CS0UB0N15K	CC 0.1 UF 10V B
C2453	CS0UB0N15K	CC 0.1 UF 10V B	C2551	CS0UB04K3K	CC 0.0027UF 50V B
C2454	CS0UB0N15K	CC 0.1 UF 10V B	C2552	CS0UB04K3K	CC 0.0027UF 50V B
C2455	CS0UB0N15K	CC 0.1 UF 10V B	C2553	CT7RC0P17M	CC 10 UF 6.3V C
C2456	CS0UB0N15K	CC 0.1 UF 10V B	<b>DIODES</b>		
C2457	CS0UB0N15K	CC 0.1 UF 10V B	D001	D2WT011E10	DIODE SILICON 11E1-EIC
C2458	CS0UB0N15K	CC 0.1 UF 10V B	D003	D2WX21DQN9	DIODE SCHOTTKY 21DQ09
C2459	CS0UB0N15K	CC 0.1 UF 10V B	D004	D2WT011E10	DIODE SILICON 11E1-EIC
C2460	CS0UB0N15K	CC 0.1 UF 10V B	D005	D97U03R31B	DIODE,ZENER MTZJ3.3B T-77
C2461	CS7RC0N17M	CC 10 UF 10V C	D104	D1VT001330	DIODE,SILICON 1SS133T-77
C2462	CS7RC0N17M	CC 10 UF 10V C	D105	D2WXS1400	DIODE SCHOTTKY SB140-EIC
C2463	CT7RC0P17M	CC 10 UF 6.3V C	D401	D2WT011E10	DIODE SILICON 11E1-EIC
C2464	CS7RC0N17M	CC 10 UF 10V C	D402	D2WT011E10	DIODE SILICON 11E1-EIC
C2465	CS0UB0N15K	CC 0.1 UF 10V B	D403	D97U03301B	DIODE,ZENER MTZJ33B T-77
C2466	CS0UB0N15K	CC 0.1 UF 10V B	D404	D97U05R61B	DIODE,ZENER MTZJ5.6B T-77
C2467	CS0UB0214K	CC 0.01 UF 16V B	△D405	D2LXN49370	DIODE,FAST RECOVERY 1N4937-F
C2468	CS0UB0214K	CC 0.01 UF 16V B	△D406	D97U05R61B	DIODE,ZENER MTZJ5.6B T-77
C2469	CS0UB0N15K	CC 0.1 UF 10V B	△D407	D2LXN49370	DIODE,FAST RECOVERY 1N4937-F
C2470	CS0UB0N15K	CC 0.1 UF 10V B	△D408	D2BFRS4FS0	DIODE,SILICON RS-4FS
C2471	CS7RC0N17M	CC 10 UF 10V C	△D409	D28F0PRA60	DIODE RECTIFIER 30PRA60-FC
C2472	CS7RC0N17M	CC 10 UF 10V C	D410	D97U03301B	DIODE,ZENER MTZJ33B T-77
C2473	CS0UB0N15K	CC 0.33 UF 10V B	△D411	D2LXN49370	DIODE,FAST RECOVERY 1N4937-F
C2474	CS0UB0413K	CC 0.001 UF 50V B	△D412	D2WXN40050	DIODE SILICON 1N4005-EIC
C2475	CS0UB0N15K	CC 0.1 UF 10V B	D414	D2WT011E10	DIODE SILICON 11E1-EIC
C2476	CS0UB0N15K	CC 0.1 UF 10V B	D415	D2WT011E10	DIODE SILICON 11E1-EIC
C2477	CS0UB0N15K	CC 0.1 UF 10V B	D416	D2WT011E10	DIODE SILICON 11E1-EIC
C2478	CS0UB0N15K	CC 0.1 UF 10V B	△D501	D2WTRM11C0	DIODE SILICON RM11C-EIC
C2479	CS0UB0N15K	CC 0.1 UF 10V B	△D502	D2WTRM11C0	DIODE SILICON RM11C-EIC
C2480	CS0UB0N15K	CC 0.1 UF 10V B	△D503	D2WTRM11C0	DIODE SILICON RM11C-EIC
C2481	CS7RC0N17M	CC 10 UF 10V C	△D504	D2WTRM11C0	DIODE SILICON RM11C-EIC
C2488	CS0UCH4Q1J	CC 47 PF 50V CH	△D505	D2WXS2900	DIODE SCHOTTKY SR290
C2489	CS0UCH4Q1J	CC 47 PF 50V CH	△D506	D2LXN49370	DIODE,FAST RECOVERY 1N4937-F
C2490	CS0UB0413K	CC 0.001 UF 50V B	D507	D1VT001330	DIODE,SILICON 1SS133T-77
C2494	CS0UB0413K	CC 0.001 UF 50V B	D508	D97U03R91B	DIODE,ZENER MTZJ3.9B T-77
C2495	CS0UCH4Q1J	CC 47 PF 50V CH	D509	D97U01501B	DIODE,ZENER MTZJ15B T-77
C2496	CS0UCH4Q1J	CC 47 PF 50V CH	△D510	D28F0PRA60	DIODE RECTIFIER 30PRA60-FC
C2497	CS0UCH4Q1J	CC 47 PF 50V CH	△D511	D2LXN49370	DIODE,FAST RECOVERY 1N4937-F
C2498	CS0UCH4Q1J	CC 47 PF 50V CH	△D512	D2WXS2900	DIODE SCHOTTKY SR290
C2499	CS0UB0N15K	CC 0.1 UF 10V B	D513	D1VT001330	DIODE,SILICON 1SS133T-77
C2501	CS0UB0413K	CC 0.001 UF 50V B	D514	D1VT001330	DIODE,SILICON 1SS133T-77
C2502	CS0UB0413K	CC 0.001 UF 50V B	D515	D1VT001330	DIODE,SILICON 1SS133T-77
C2503	CS0UB0413K	CC 0.001 UF 50V B	D516	D1VT001330	DIODE,SILICON 1SS133T-77
C2504	CS0UB0413K	CC 0.001 UF 50V B	D517	D2LXN49370	DIODE,FAST RECOVERY 1N4937-F
C2507	CS7RC0N17M	CC 10 UF 10V C	△D523	D97U01801B	DIODE,ZENER MTZJ18B T-77
C2508	CS7RC0N17M	CC 10 UF 10V C	D524	D1VT001330	DIODE,SILICON 1SS133T-77
C2509	CS0UCH4S1J	CC 56 PF 50V CH	D525	D97U05R61B	DIODE,ZENER MTZJ5.6B T-77
C2510	CS0UB0N15K	CC 0.1 UF 10V B	D528	D97U05R61B	DIODE,ZENER MTZJ5.6B T-77
C2511	CS0UB0N15K	CC 0.1 UF 10V B	△D529	D2WXS2900	DIODE SCHOTTKY SR290
C2512	CS7RC0N17M	CC 10 UF 10V C	D530	D97U01001B	DIODE,ZENER MTZJ10B T-77
C2513	CS7RC0N17M	CC 10 UF 10V C	D531	D97U03301B	DIODE,ZENER MTZJ33B T-77
C2518	CS0UB0413K	CC 0.001 UF 50V B	D532	D97U01101B	DIODE,ZENER MTZJ11B T-77
C2519	CS0UB0413K	CC 0.001 UF 50V B	D533	D1VT001330	DIODE,SILICON 1SS133T-77
C2520	CS0UB0413K	CC 0.001 UF 50V B	D535	D97U04R71B	DIODE,ZENER MTZJ4.7B T-77
C2521	CS0UB0413K	CC 0.001 UF 50V B	D536	D1VT001330	DIODE,SILICON 1SS133T-77
C2522	E72KM0221D	CE 220 UF 6.3V	D539	D1VT001330	DIODE,SILICON 1SS133T-77
C2523	E72KM0221D	CE 220 UF 6.3V	D611	D1VT001330	DIODE,SILICON 1SS133T-77
C2524	E72KM0221D	CE 220 UF 6.3V	D612	D1VT001330	DIODE,SILICON 1SS133T-77
C2525	E72KM0221D	CE 220 UF 6.3V	D801	D1VT001330	DIODE,SILICON 1SS133T-77
C2530	CS0UCH421J	CC 20 PF 50V CH	D802	D1VT001330	DIODE,SILICON 1SS133T-77
C2531	CS0UCH421J	CC 20 PF 50V CH	D803	D1VT001330	DIODE,SILICON 1SS133T-77
C2533	CS0UCH4L1J	CC 33 PF 50V CH	D810	D1VT001330	DIODE,SILICON 1SS133T-77
C2534	CS0UCH4L1J	CC 33 PF 50V CH	D811	D1VT001330	DIODE,SILICON 1SS133T-77
C2535	CS0UCH4L1J	CC 33 PF 50V CH	D812	D1VT001330	DIODE,SILICON 1SS133T-77
C2536	CS0UCH4L1J	CC 33 PF 50V CH	D2401	DD7R0S3550	DIODE SILICON 1SS355 TE-17
C2537	CS0UCH412J	CC 100 PF 50V CH	<b>ICs</b>		
C2538	CS0UCH412J	CC 100 PF 50V CH	△IC001	I07F9E00W0	VO1=3.3V VO2=0.8-3.3V IO=0.6 BA33E00WHFP-TR
C2539	CS0PB0NH6K	CC 2.2 UF 10V B	IC005	I0CJ040530	ANALOG SW 3IN-2OUT SN74LV4053APWR
C2540	CS0PB0NH6K	CC 2.2 UF 10V B	IC101	I56F07180A	2007 USA 27 SD DTV VA OEC7180A
C2541	CS7RC0N17M	CC 10 UF 10V C	IC102	I9UF032450	RESET IC 4.5V TYPE PST3245NR
C2542	CS7RC0N17M	CC 10 UF 10V C	IC199	S33A01SE01	MEMORY DATA EEPROM 8K SOIC AT24C08AN-10SU-2.7
C2543	CS7RC0N17M	CC 10 UF 10V C	IC201	I03FA56760	VIF/SIF IC LA75676V-S
C2544	CS0UB0N15K	CC 0.1 UF 10V B	△IC401	I03SD78470	VERTICAL DRIVE 10PIN LA7847-E
C2545	CS7RC0N17M	CC 10 UF 10V C	△IC504	000220002W	PHOTO COUPLER PS2561AL1-1-V(W)
C2546	CT7RC0P17M	CC 10 UF 6.3V C	IC601	I03FC6327B	TV 1CHIP JUMBO 64PIN LA76327M-B-MPB-E

# ELECTRICAL REPLACEMENT PARTS LIST

REF. NO.	PART NO.	DESCRIPTION	REF. NO.	PART NO.	DESCRIPTION
<b>ICs</b>					
IC602	I0QF022830	A/V SW 2INPUT 1 OUTPUT			
IC701	I0QF027500	4INPUT 1OUTPUT AUDIO SW			
IC901	I03FF27000	US MTS DECODER			
△IC1001	I0FSP7822A	SOUND AMP 5W*2CH STEREO			
IC2401	I56F069530	USA DTV CHIPSET			
IC2402	I0LJ022EC5	256MB DDR SDRAM			
	I0LJ022ET5	256MB DDR SDRAM			
IC2403	S33A01SF01	MEMORY DATA 32M BIT FLASH MEMORY			
IC2405	I1FF043480	AUDIO DAC 192KHZ 24BIT			
IC2406	I0QF0580V0	AUDIO OPERATION AMP			
IC2408	I07F0C5WF0	REGULATOR			
<b>TRANSISTORS</b>					
Q001	TAAT01281Y	TRANSISTOR SILICON			
Q002	TNAAB05003	COMPOUND TRANSISTOR			
Q003	T2AA5132E0	FET			
Q004	T2AA5132E0	FET			
Q005	T2AA5132E0	FET			
Q006	T2AA5132E0	FET			
Q007	TCAA3875SY	TRANSISTOR SILICON			
Q008	TNAAC05002	COMPOUND TRANSISTOR			
Q106	TAAA1504SY	TRANSISTOR SILICON			
Q107	TPAAC05002	COMPOUND TRANSISTOR			
Q201	TAAA1504SY	TRANSISTOR SILICON			
△Q402	TCAT03227Y	TRANSISTOR SILICON			
△Q405	TUUU024990	TRANSISTOR SILICON			
△Q501	TC4TC32030	TRANSISTOR SILICON			
△Q502	TJXG10NK50	FET			
△Q503	TL4T1371E0	TRANSISTOR SILICON			
Q504	TC4T031980	TRANSISTOR SILICON			
△Q505	TT4T2909R0	TRANSISTOR SILICON			
Q506	TNAAD05001	COMPOUND TRANSISTOR			
△Q507	TC4T031980	TRANSISTOR SILICON			
△Q508	TAAT012714	TRANSISTOR, SILICON			
Q509	TC4T031980	TRANSISTOR SILICON			
Q510	TNAAD05001	COMPOUND TRANSISTOR			
△Q514	TC4TC32030	TRANSISTOR SILICON			
Q601	TNAAB05003	COMPOUND TRANSISTOR			
Q602	TT4T03209Y	TRANSISTOR SILICON			
Q603	TAATA12660	TRANSISTOR,SILICON			
Q605	TPAAB05001	COMPOUND TRANSISTOR			
Q607	TT4T03209Y	TRANSISTOR SILICON			
Q608	TDA0016910	TRANSISTOR SILICON			
Q609	TDA0016910	TRANSISTOR SILICON			
Q610	TCAA3875SY	TRANSISTOR SILICON			
Q611	TT4T03209Y	TRANSISTOR SILICON			
Q612	TCAA3875SY	TRANSISTOR SILICON			
Q701	TCAA3875SY	TRANSISTOR SILICON			
Q704	TCAA3875SY	TRANSISTOR SILICON			
△Q801	TCATC3199Y	TRANSISTOR SILICON			
△Q802	TCATC3199Y	TRANSISTOR SILICON			
△Q803	TCATC3199Y	TRANSISTOR SILICON			
△Q804	TC4TC42170	TRANSISTOR SILICON			
△Q805	TC4TC42170	TRANSISTOR SILICON			
△Q806	TC4TC42170	TRANSISTOR SILICON			
Q1001	TCAA3875SY	TRANSISTOR SILICON			
Q2401	T2AA5132E0	FET			
Q2402	T2AA5132E0	FET			
<b>COILS &amp; TRANSFORMERS</b>					
L001	02167BR22K	COIL	0.22	UH	
L004	021LA6R22M	COIL	0.22	UH	
L005	021LA6R22M	COIL	0.22	UH	
L101	021LA62R2K	COIL	2.2	UH	
L204	021LA6120K	COIL	12	UH	
L205	033702007N	COIL	3702007		
L206	021LA6270K	COIL	27	UH	
L207	021L7L220J	COIL	22	UH	
L208	021LA6330J	COIL	33	UH	
△L402	022K00058A	COIL,LINEARITY	311015027		
△L403	02DK000058	COIL CHOKE	02DK000058		
△L501	029T000152	COIL,LINE FILTER	2R0A902F28YNP	or	
	029X000098	COIL,LINE FILTER	SS28H-20075		
△L503	028T270021	COIL,DEGAUSS	T028R27021		
L601	021LA6220J	COIL	22	UH	
L603	021L7L150J	COIL	15	UH	
L801	02167D151K	COIL	150	UH	
L901	021L7L101J	COIL	100	UH	
L2401	021AS9224J	COIL	0.22	UH	
<b>COILS &amp; TRANSFORMERS</b>					
T401	0450190171	TRANS,HORIZONTAL DRIVE			ETH19Y206AY
△T501	0481350994	TRANSFORMER,SWITCHING			81350994
<b>JACKS</b>					
J701	060J431020	RCA JACK			MSP-213V2-432_NI_LF
J702	063E700012	JACK			S4-25SZ
J703	060J411045	RCA JACK			MSP-382V-12_NL_FE_LF
J704	060J411032	RCA JACK			MSP-213V1-652_NL_LF
J705	060K421056	RCA JACK			AV-5A-66H
J706	060K421058	RCA JACK			AV-5A-68H
J707	060K421057	RCA JACK			AV-5A-67H
△J801	066F130026	SOCKET,CATHODE RAY TUBE			ISHD62S
<b>SWITCHES</b>					
SW101	0504101T34	SWITCH,TACT			EVQ21505R
SW102	0504101T34	SWITCH,TACT			EVQ21505R
SW103	0504101T34	SWITCH,TACT			EVQ21505R
SW104	0504101T34	SWITCH,TACT			EVQ21505R
SW105	0504101T34	SWITCH,TACT			EVQ21505R
<b>VARIABLE RESISTORS</b>					
VR401	V1K63H3BTE	VOLUME,SEMI FIXED			NVG6TLTAB222
VR502	V1163H4BTC	VOLUME,SEMI FIXED			EVNCRYAA03BE4
<b>P.C.BOARD ASSEMBLIES</b>					
PCB070	A33A01S070	TV MT PCB ASS'Y			CMG117B
PCB110	A33A01S110	CRT PCB ASS'Y			CCG080B
PCBDH0	A33A01SDH0	DIGITAL PCB ASS'Y			CEF284B
<b>MISCELLANEOUS</b>					
B002	024HC51023	CORE,BEADS			FCM1608KF-102T02
B004	024HC51023	CORE,BEADS			FCM1608KF-102T02
B401	024HT03564	CORE,BEADS			W4BRH3.5X6X1.0
B402	024HT03564	CORE,BEADS			W4BRH3.5X6X1.0
B405	024HT03564	CORE,BEADS			W4BRH3.5X6X1.0
△B501	024HT03563	CORE,BEADS			W4BRH3.5X6X1.0X2
△B504	024HT03553	CORE,BEADS			W5RH3.5X5X1.0
B601	024HT03564	CORE,BEADS			W4BRH3.5X6X1.0
B2401	024HC51513	CORE,BEADS			FCM1608KF-151T06
B2402	024HC51513	CORE,BEADS			FCM1608KF-151T06
B2403	024HC51513	CORE,BEADS			FCM1608KF-151T06
B2404	024HC51023	CORE,BEADS			FCM1608KF-102T02
B2405	024HC51023	CORE,BEADS			FCM1608KF-102T02
B2406	024HC51023	CORE,BEADS			FCM1608KF-102T02
B2410	024HC51023	CORE,BEADS			FCM1608KF-102T02
B2411	024HC51023	CORE,BEADS			FCM1608KF-102T02
B2412	024HC51023	CORE,BEADS			FCM1608KF-102T02
B2413	024HC51023	CORE,BEADS			FCM1608KF-102T02
B2414	024HC51023	CORE,BEADS			FCM1608KF-102T02
B2417	024HC16014	CORE,BEADS			HCB3216KF-601T20
B2418	024HC16014	CORE,BEADS			HCB3216KF-601T20
B2419	024HC16014	CORE,BEADS			HCB3216KF-601T20
B2420	024HC16014	CORE,BEADS			HCB3216KF-601T20
B2423	024HC51513	CORE,BEADS			FCM1608KF-151T06
△CD501	120Q414913	CORD AC BUSH			P201-2469-2
CD801	WCL6840038	FLAT CABLE AWM2468			AWG26 5C GRAY 400MM
CD802	WDL6058038	FLAT CABLE AWM2468			AWG26 6C BLACK 580MM
CD804	06E8013001	CORD CONNECTOR			E8013001
CF201	1012T4R520	FILTER,CERAMIC			SFSRAAM50CF00-A0
CF203	1012T4R519	FILTER,CERAMIC TRAP			TPSRA4M50C00-A0
CF204	102E045R7J	FILTER,SAW			M1879M
CP101	069S280639	CONNECTOR PCB SIDE			A2001WR2-8P
△CP401	069S460089	CORD UX CONNECTOR			A1561VV2-A6P
△CP502	069S420110	CONNECTOR PCB SIDE			A1561VV2-2P
CP804	069D01001A	CONNECTOR PCB SIDE			003P-2100
CD1001	06E8146001	CORD CONNECTOR			E8146001
CP1001	069S140419	CONNECTOR PCB SIDE			A2502VV2-4P
CP2401	069S2S001C	CONNECTOR PCB SIDE			A2003WR2-1FX28P
CP2402	069S2B0639	CONNECTOR PCB SIDE			A2001WR2-11P
CP801A	067U005049	WIRE HOLDER			B2013H02-5P
CP801B	067U005049	WIRE HOLDER			B2013H02-5P
CP802A	067U006049	WIRE HOLDER			B2013H02-6P
CP802B	067U006049	WIRE HOLDER			B2013H02-6P
CUS071	800WFAA006	CUSHION A			
EL0701	124116281A	EYE LET			XRY16X28BD
EL0702	124120301A	EYE LET			XRY20X30BD
△F501	081PC6R305	FUSE			51MS063L
△FB401	043227016F	TRANSFORMER,FLYBACK			FJN27A003_M
FH501	06710T0009	HOLDER,FUSE			EYF-52BCY
FH502	06710T0009	HOLDER,FUSE			EYF-52BCY
NR2401	110P4470M5	R.NETWORK			4D02WGJ0470TCE
NR2402	110P4470M5	R.NETWORK			4D02WGJ0470TCE

# ELECTRICAL REPLACEMENT PARTS LIST

REF. NO.	PART NO.	DESCRIPTION	
<b>MISCELLANEOUS</b>			
NR2403	110P4470M5	R,NETWORK	4D02WGJ0470TCE
NR2404	110P4470M5	R,NETWORK	4D02WGJ0470TCE
NR2405	110P4470M5	R,NETWORK	4D02WGJ0470TCE
NR2406	110P4470M5	R,NETWORK	4D02WGJ0470TCE
NR2407	110P4470M5	R,NETWORK	4D02WGJ0470TCE
NR2408	110P4470M5	R,NETWORK	4D02WGJ0470TCE
NR2409	110P4470M5	R,NETWORK	4D02WGJ0470TCE
NR2410	110P4220M5	R,NETWORK	4D02WGJ0220TCE
NR2411	110P4220M5	R,NETWORK	4D02WGJ0220TCE
NR2412	110P4220M5	R,NETWORK	4D02WGJ0220TCE
NR2413	110P4220M5	R,NETWORK	4D02WGJ0220TCE
NR2414	110P4220M5	R,NETWORK	4D02WGJ0220TCE
NR2415	110P4220M5	R,NETWORK	4D02WGJ0220TCE
NR2416	110P4220M5	R,NETWORK	4D02WGJ0220TCE
NR2417	110P4220M5	R,NETWORK	4D02WGJ0220TCE
NR2418	110P4220M5	R,NETWORK	4D02WGJ0220TCE
NR2420	110P4220M5	R,NETWORK	4D02WGJ0220TCE
OS101	077A038004	REMOTE RECEIVER	ROM-V338SYN
	077A038003	REMOTE RECEIVER	ROM-V338SY
△RY501	0560V20119	RELAY	ALKS321_M60
△SP1001	070Y435022	SPEAKER	S0509F75
△SP1002	070Y435022	SPEAKER	S0509F75
△TH501	D8EE0B1400	DEGAUSS ELEMENT	B59203-S1060-B14
	DF5EL3R0A0	DEGAUSS ELEMENT	ZPB45BL3R0A
△TU001	0164600024	DIGITAL TUNER	TDQU2-H07A
△V801	098S270606	CRT W/DY	A68QBC520X35L
X101	100GT01215	CRYSTAL	B12000E011
X102	100DA32R01	CRYSTAL	DT-26
X601	100DT3R531	CRYSTAL	HC-49/U
X2401	100GA02504	CRYSTAL	B25000E023

**RESISTOR**

RC..... CARBON RESISTOR

**CAPACITORS**

CC..... CERAMIC CAPACITOR  
 CE..... ALUMI ELECTROLYTIC CAPACITOR  
 CP..... POLYESTER CAPACITOR  
 CPP..... POLYPROPYLENE CAPACITOR  
 CPL..... PLASTIC CAPACITOR  
 CMP..... METAL POLYESTER CAPACITOR  
 CMPL..... METAL PLASTIC CAPACITOR  
 CMPP..... METAL POLYPROPYLENE CAPACITOR

---

### HOW TO ORDER PARTS

When placing a parts order, please have the following information.

A. MODEL NUMBER and VERSION NUMBER

Located on the back of the unit.

EX: VR0100 (Model no.), VERSION/A (Version no.)

B. PART NO. and DESCRIPTION

Located in your SERVICE MANUAL. (See pages M1-1~M2-7)

EX: I235953420, STK5342, Voltage Regulator

↑  
PART NO.

↑  
DESCRIPTION

C. QUANTITY

D. Mailing address and NAME

EX: ABC Service Center  
111 Broadway  
NEW YORK, N.Y. 10005

ATTN: MR. X Y Z

ORION SALES, INC.  
HIGHWAY 41  
ORION PLACE  
PRINCETON, INDIANA 47670

---

---

ORION SALES, INC.  
HIGHWAY 41  
ORION PLACE  
PRINCETON, INDIANA 47670

---